



**Buglo**



# Trampolines 2.0

NEW PRODUCTS 2024



## Advantages for physical development



Sensory  
Integration



Jumping

Great exercise for motor control

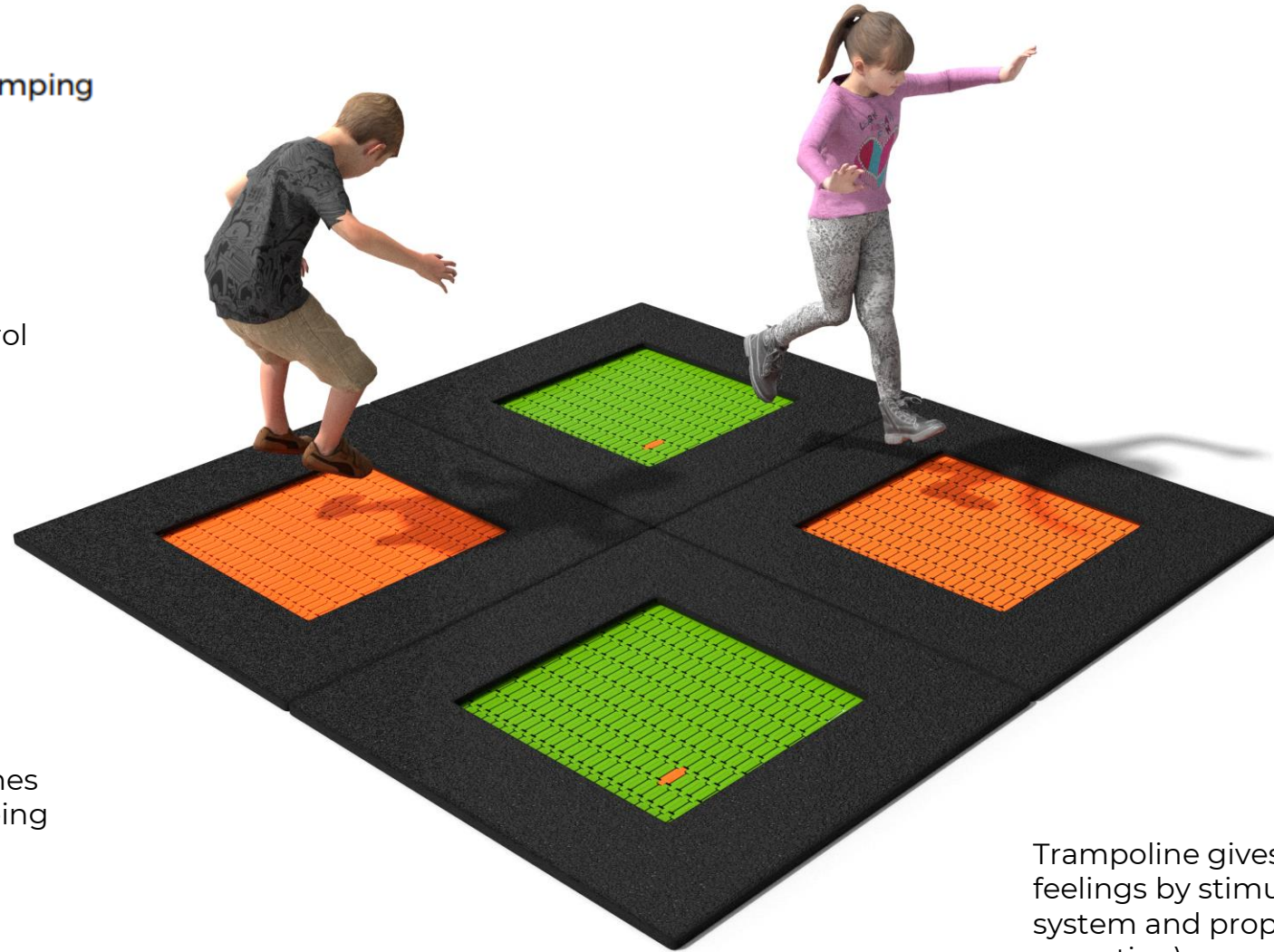

Jumping on trampolines strengthens muscles, improves balance and coordination.

While jumping on trampolines every part of the body is being activated.

Trampoline gives a lot of sensory feelings by stimulating our visual system and proprioception (deep sensation)



# Operational Characteristics

Manufacturing  
time – **standard**

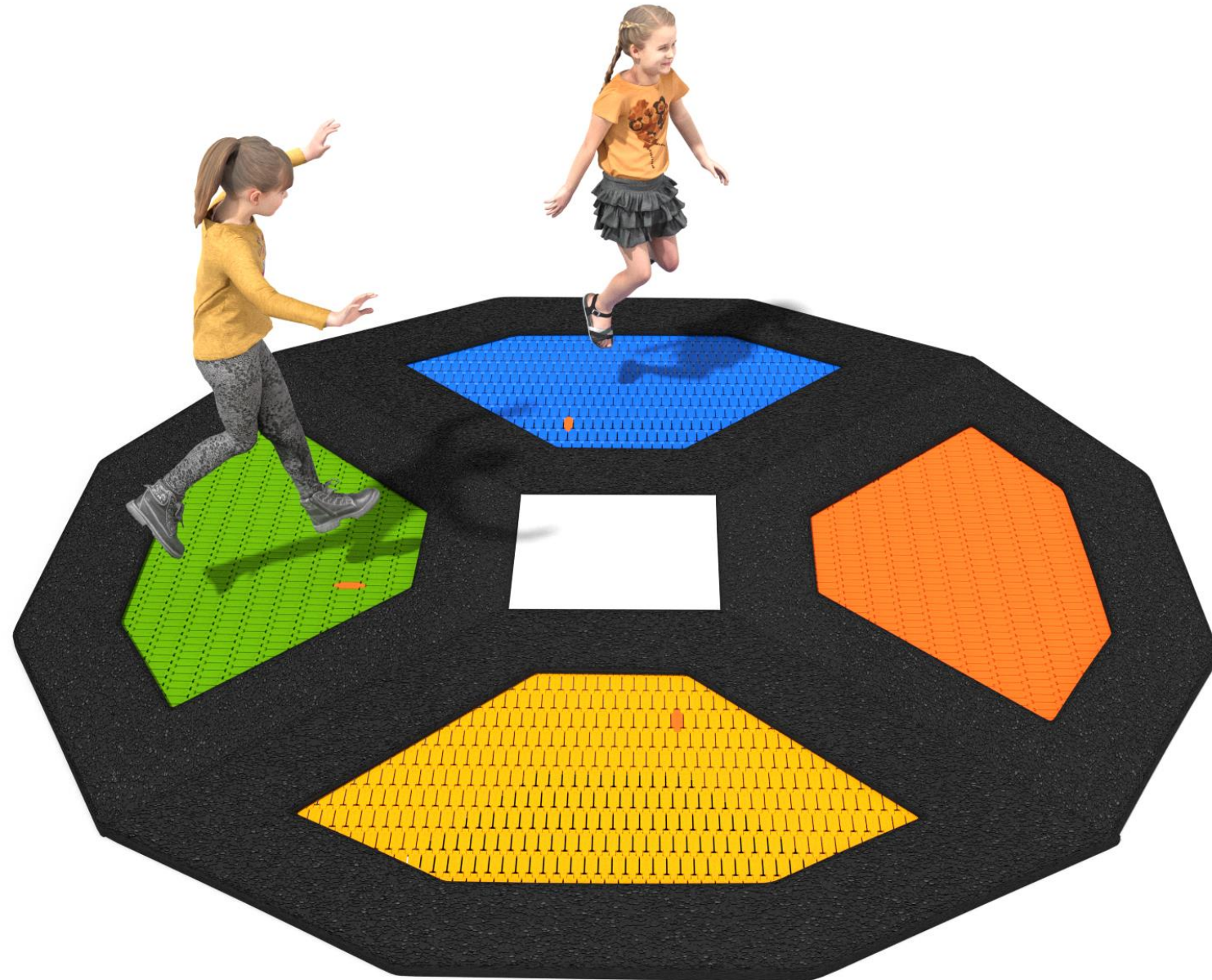





## What is new?

New Trampoline slats 2.0

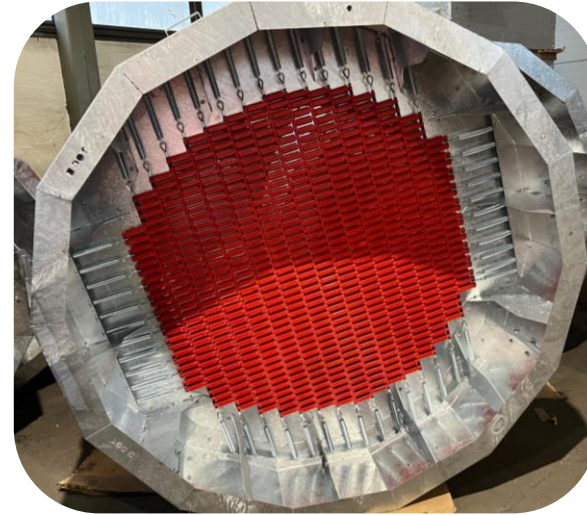
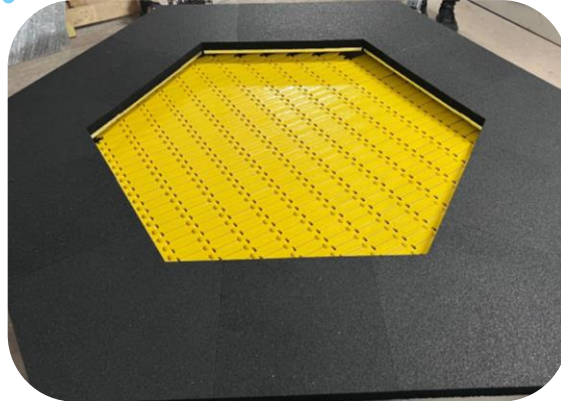

Improved construction

New rubber mats (SBR/EPDM)



Rubber mats in colour: always black with possibility of colourful grains





Jumping mat suspended to the construction on handles 5 mm thick

168 mm Hot dip galvanised springs, made of 3,2 mm rods



## Characteristics

30 cm wide SBR (black) /EPDM (colour) sides 30 mm thick- cut out of a pressed sheet – not poured

Construction made of 2 mm metal sheet hot dip galvanised strengthened by brackets welded 35-45 cm apart



# Characteristics of Jumpig Mat

**Approx. 3mm gaps between the slats!**

Anti slip structure on the jumping area

Smaller gaps - Better protection against dirtiness in the trampoline

Jumping slats available in 8 colours

Trampoline slats threaded on a 5 mm stainless steel cord in PVC jacket.



Create your graphics on the jumping mat







# Characteristics of Jumping Mat

## Exemplary graphics on jumping mats

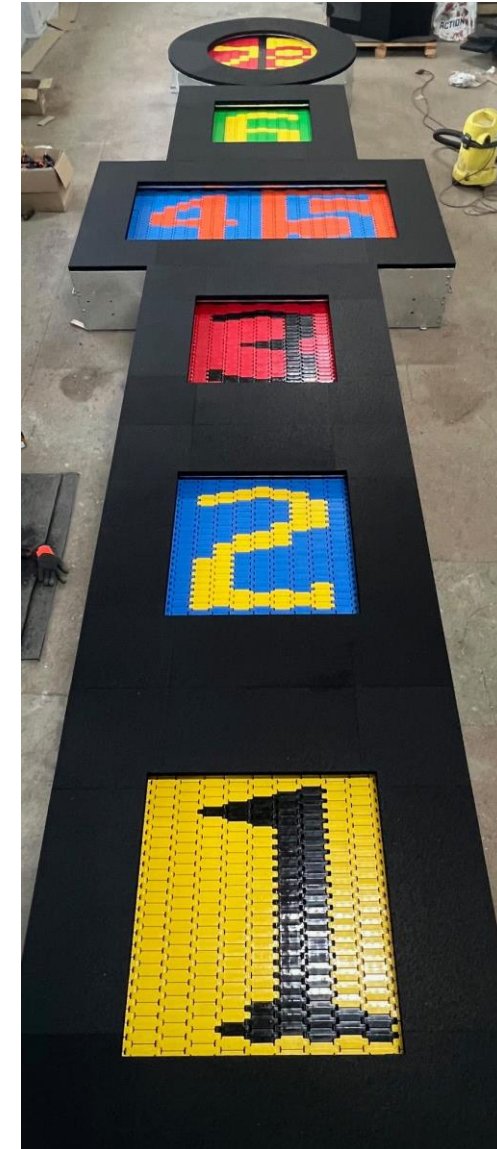
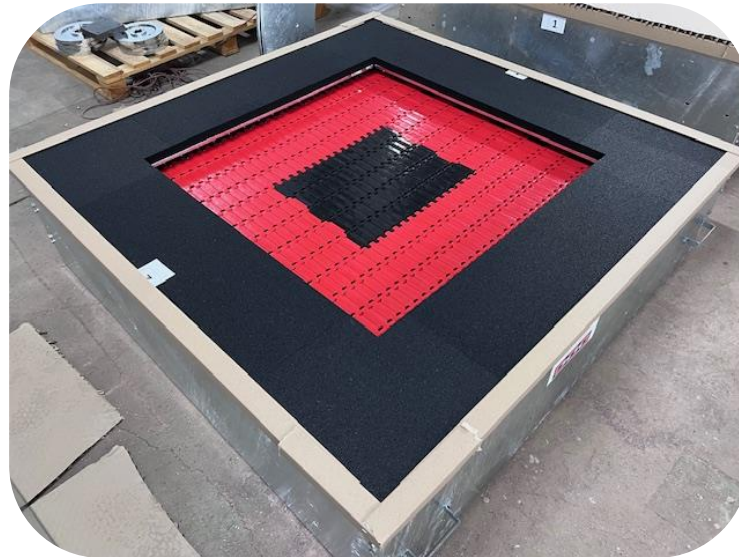
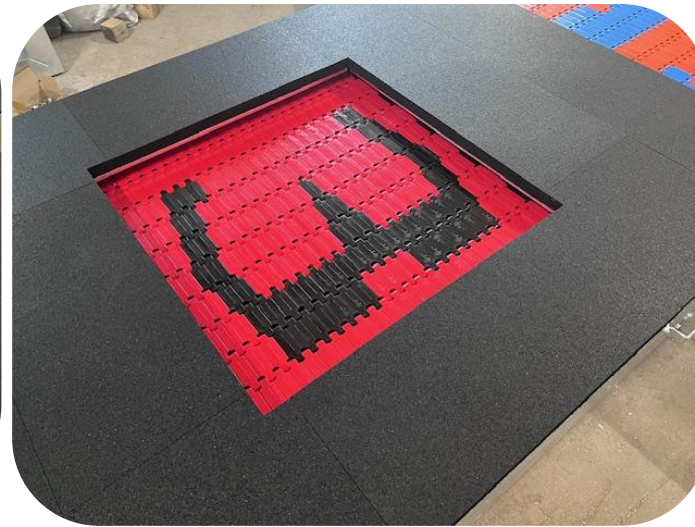
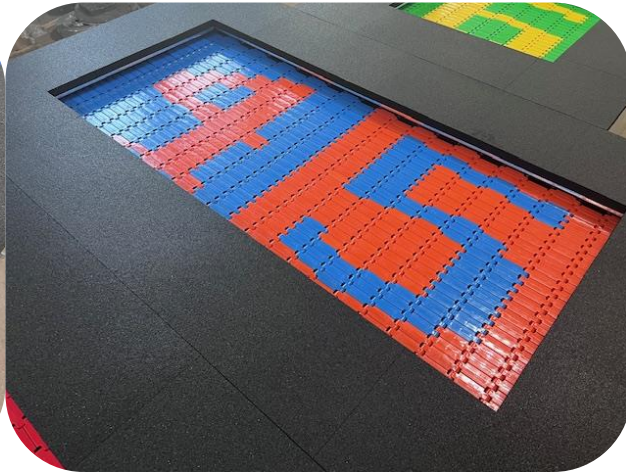
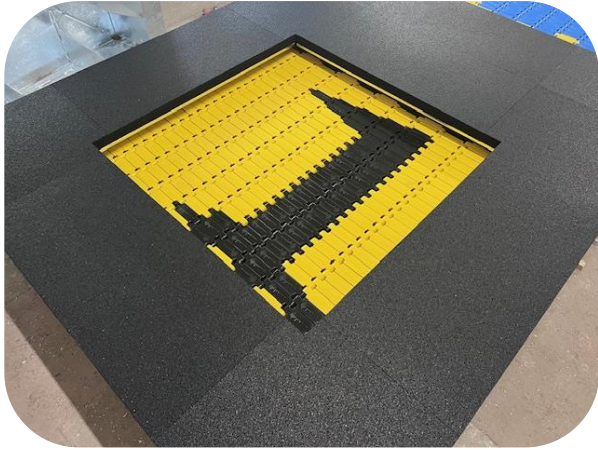

# Trampolines 2.0

Get a new experience of jumping on the new generation of trampolines. Jumping mat with minimum gaps and anti slip structure make it even more fun to use.

## MATERIALS:

1 Hot dip galvanised construction

2 Jumping mat 

3 Rubber sides   
Black Green Red Yellow Blue

4201

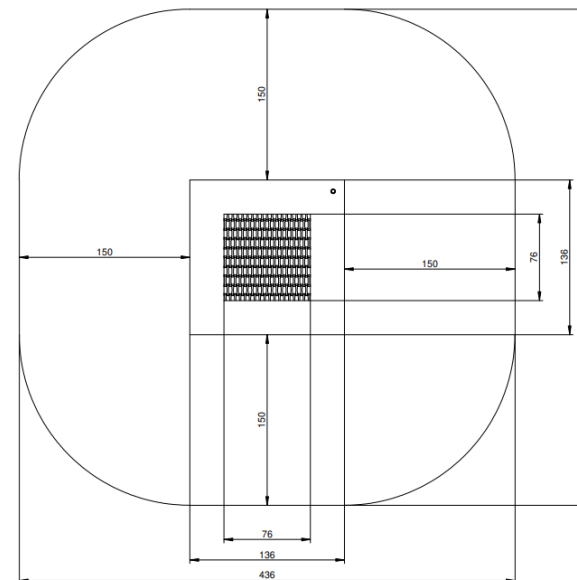
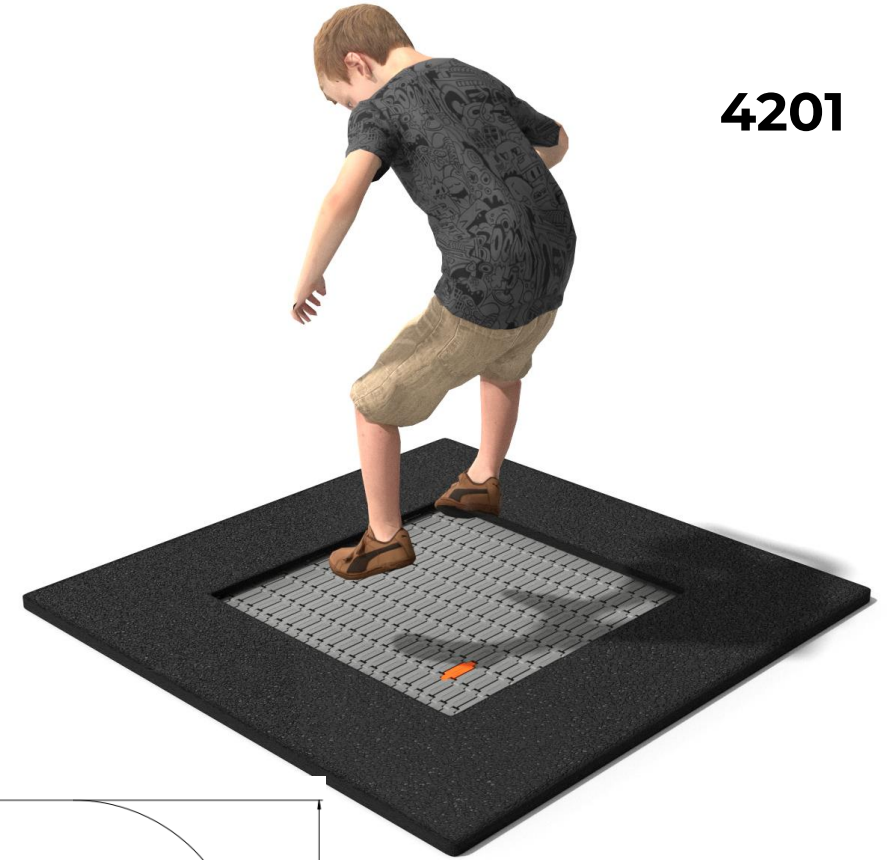



# Trampolines 2.0

4202

Get a new experience of jumping on the new generation of trampolines. Jumping mat with minimum gaps and anti slip structure make it even more fun to use.

## MATERIALS:

1 Hot dip galvanised construction

2 Jumping mat 

3 Rubber sides   
Black Green Red Yellow Blue

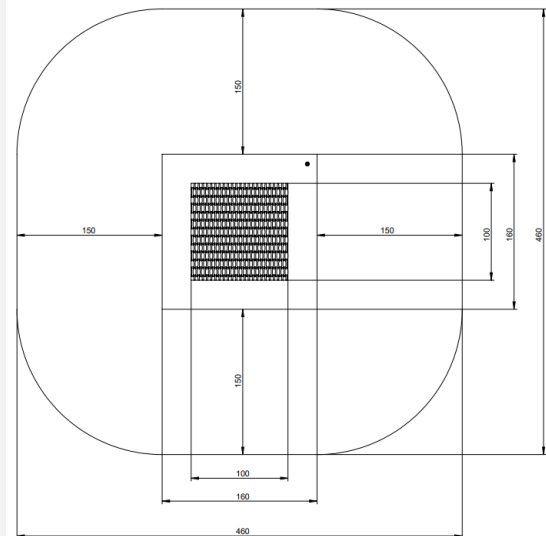
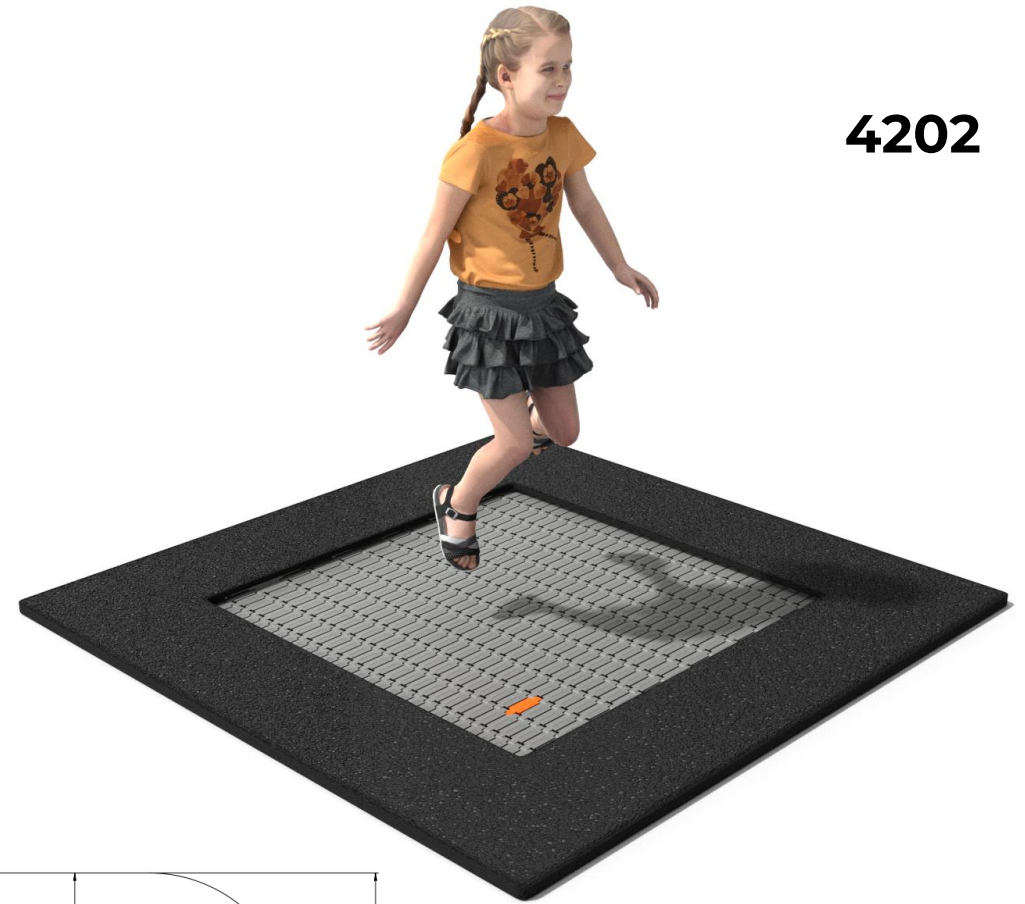

# Trampolines 2.0

Get a new experience of jumping on the new generation of trampolines. Jumping mat with minimum gaps and anti slip structure make it even more fun to use.

## MATERIALS:

1 Hot dip galvanised construction

2 Jumping mat



3 Rubber sides



Black

Green

Red

Yellow

Blue

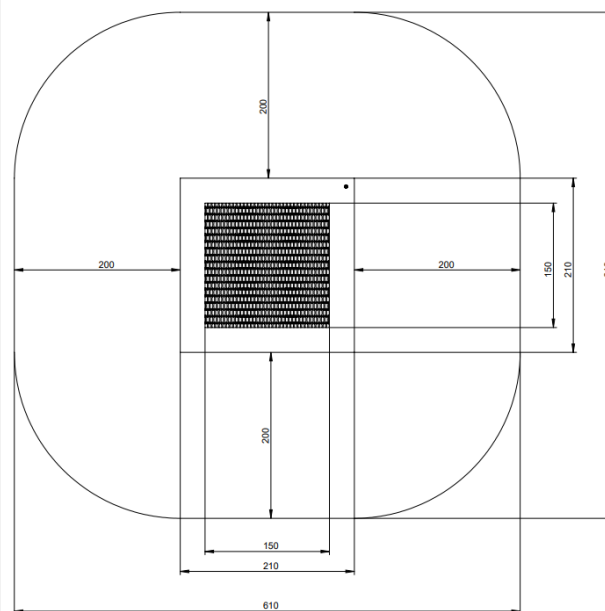



# Trampolines 2.0

4204

Get a new experience of jumping on the new generation of trampolines. Jumping mat with minimum gaps and anti slip structure make it even more fun to use.

## MATERIALS:

1 Hot dip galvanised construction

2 Jumping mat 

3 Rubber sides   
Black    Green    Red    Yellow    Blue

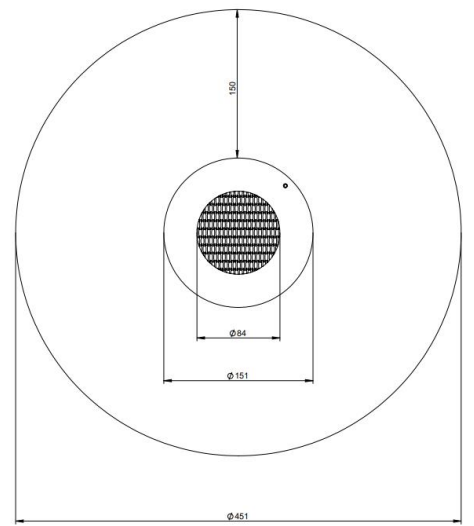
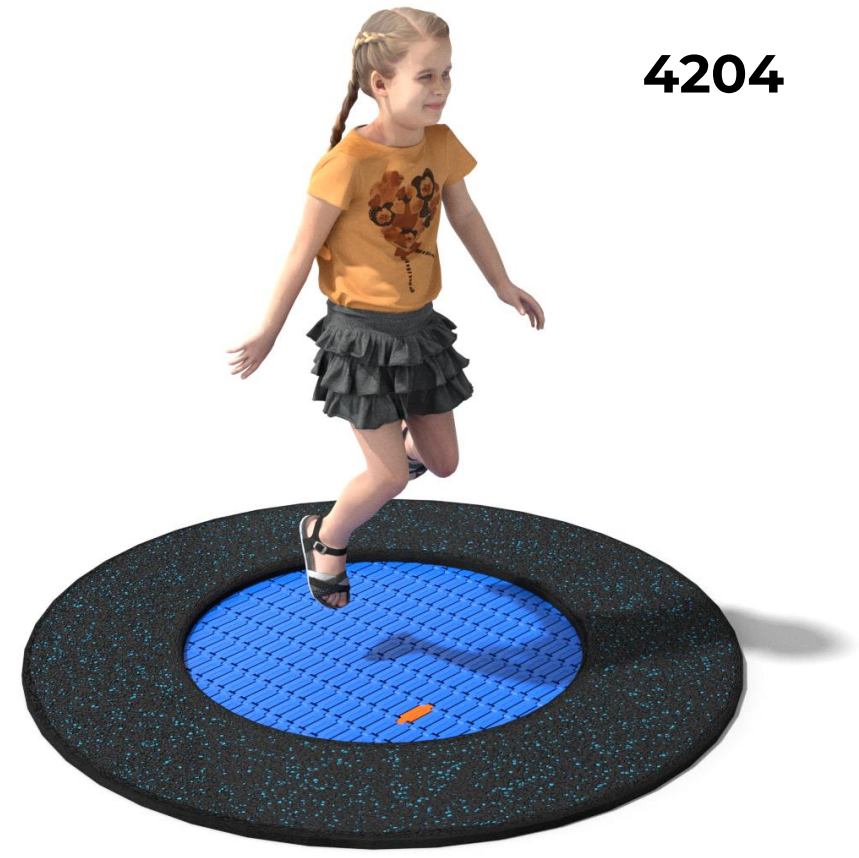

# Trampolines 2.0

Get a new experience of jumping on the new generation of trampolines. Jumping mat with minimum gaps and anti slip structure make it even more fun to use.

MATERIALS:

- 1 Hot dip galvanised construction
- 2 Jumping mat

- 3 Rubber sides
- Black    Green    Red    Yellow    Blue

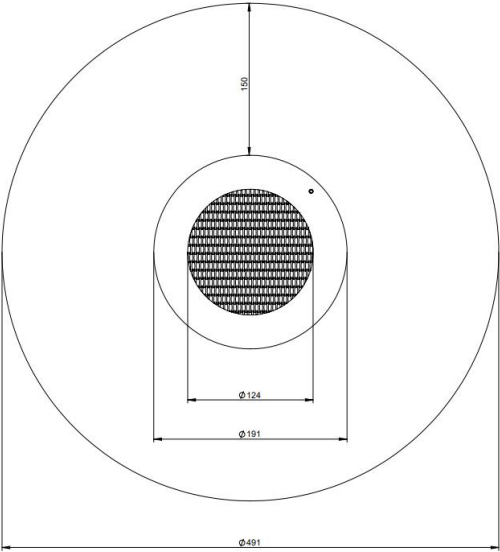
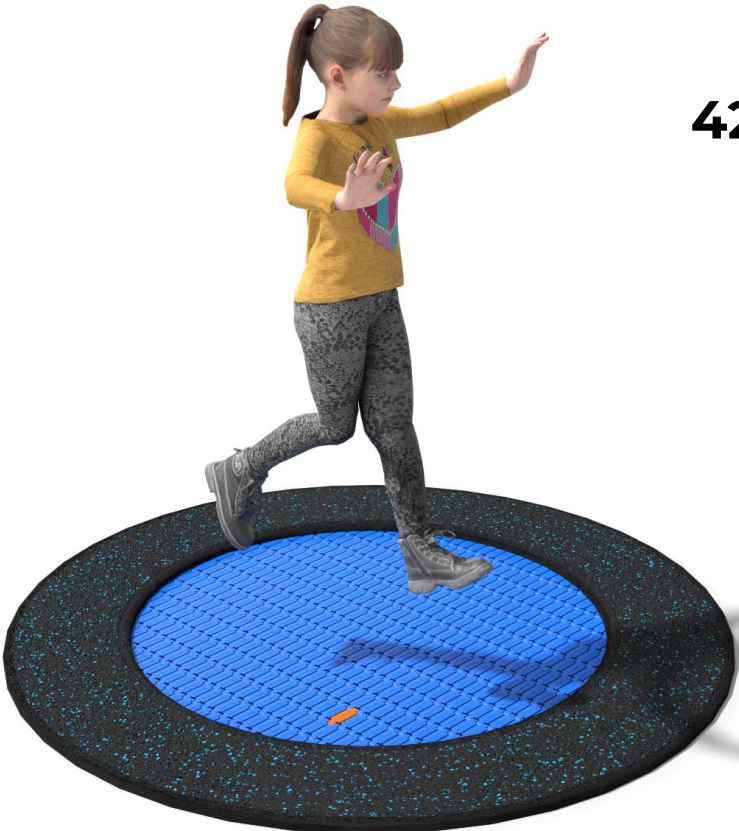



# Trampolines 2.0

Get a new experience of jumping on the new generation of trampolines. Jumping mat with minimum gaps and anti slip structure make it even more fun to use.

## MATERIALS:

1 Hot dip galvanised construction

2 Jumping mat 

3 Rubber sides 

Black    Green    Red    Yellow    Blue

4206

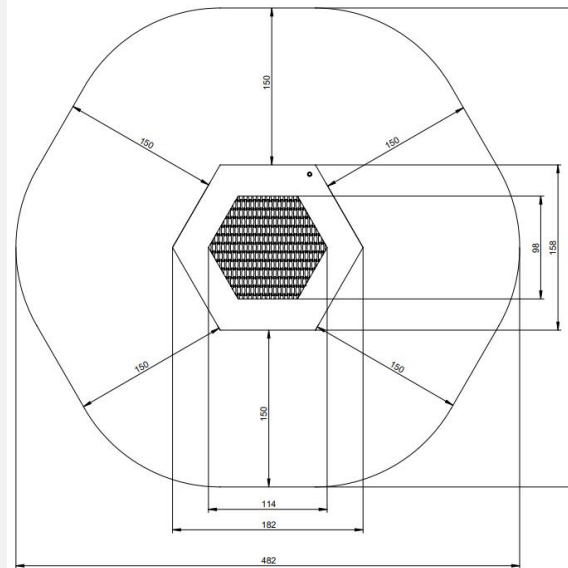

# Trampolines 2.0

4207

Get a new experience of jumping on the new generation of trampolines. Jumping mat with minimum gaps and anti slip structure make it even more fun to use.

## MATERIALS:

- 1 Hot dip galvanised construction
- 2 Jumping mat 

- 3 Rubber sides   
Black    Green    Red    Yellow    Blue

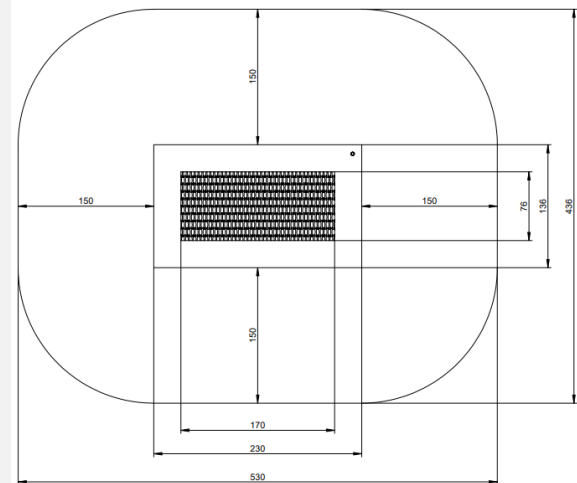
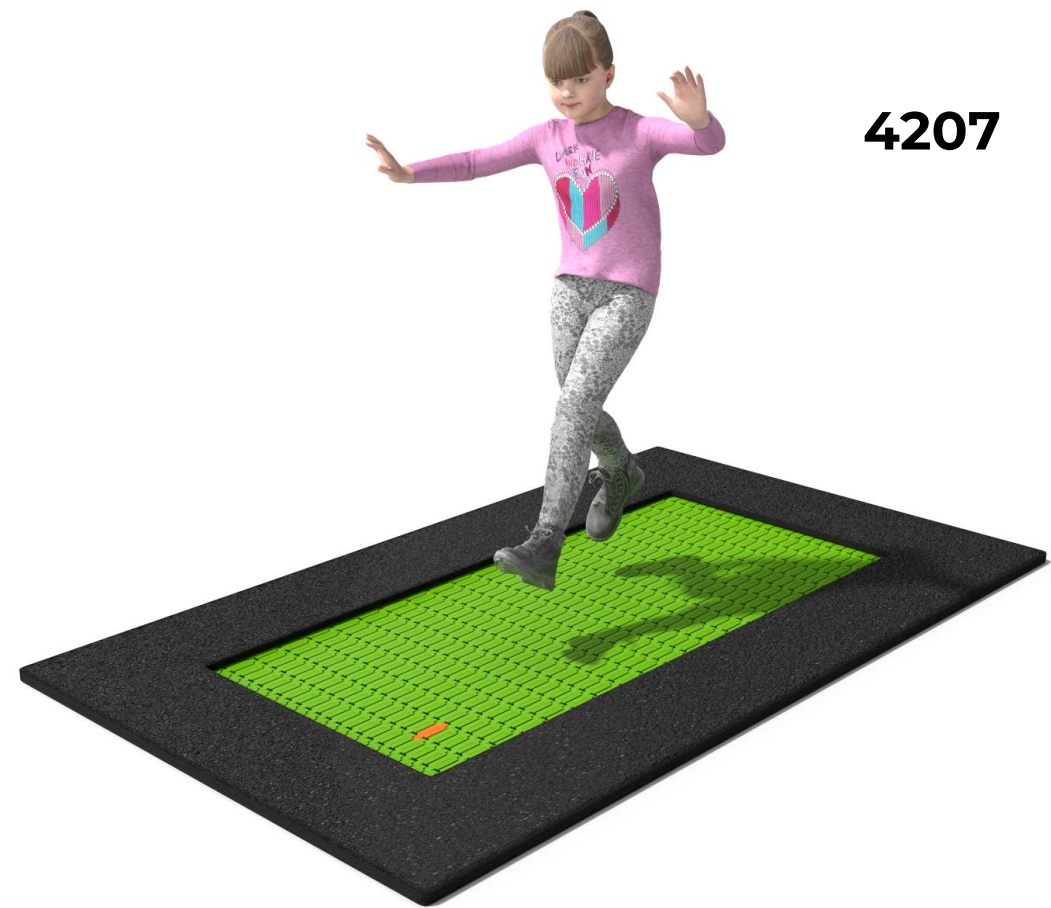



# Trampolines 2.0

Get a new experience of jumping on the new generation of trampolines. Jumping mat with minimum gaps and anti slip structure make it even more fun to use.

MATERIALS:

1 Hot dip galvanised construction

2 Jumping mat 

3 Rubber sides   
 Black    Green    Red    Yellow    Blue

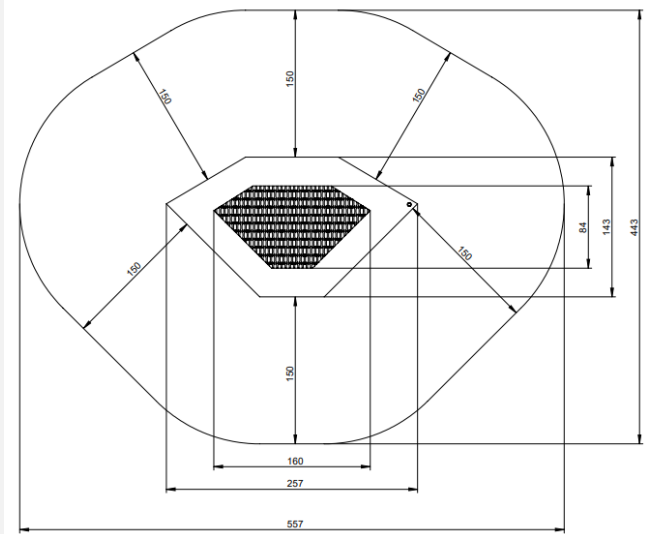

# Trampolines 2.0

Get a new experience of jumping on the new generation of trampolines. Jumping mat with minimum gaps and anti slip structure make it even more fun to use.

MATERIALS:

1 Hot dip galvanised construction

2 Jumping mat 

3 Rubber sides   
 Black    Green    Red    Yellow    Blue

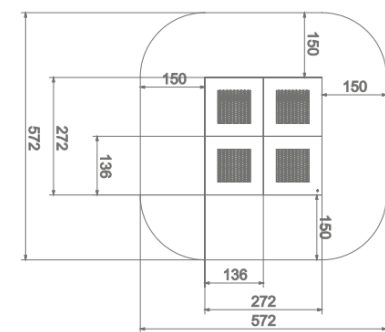
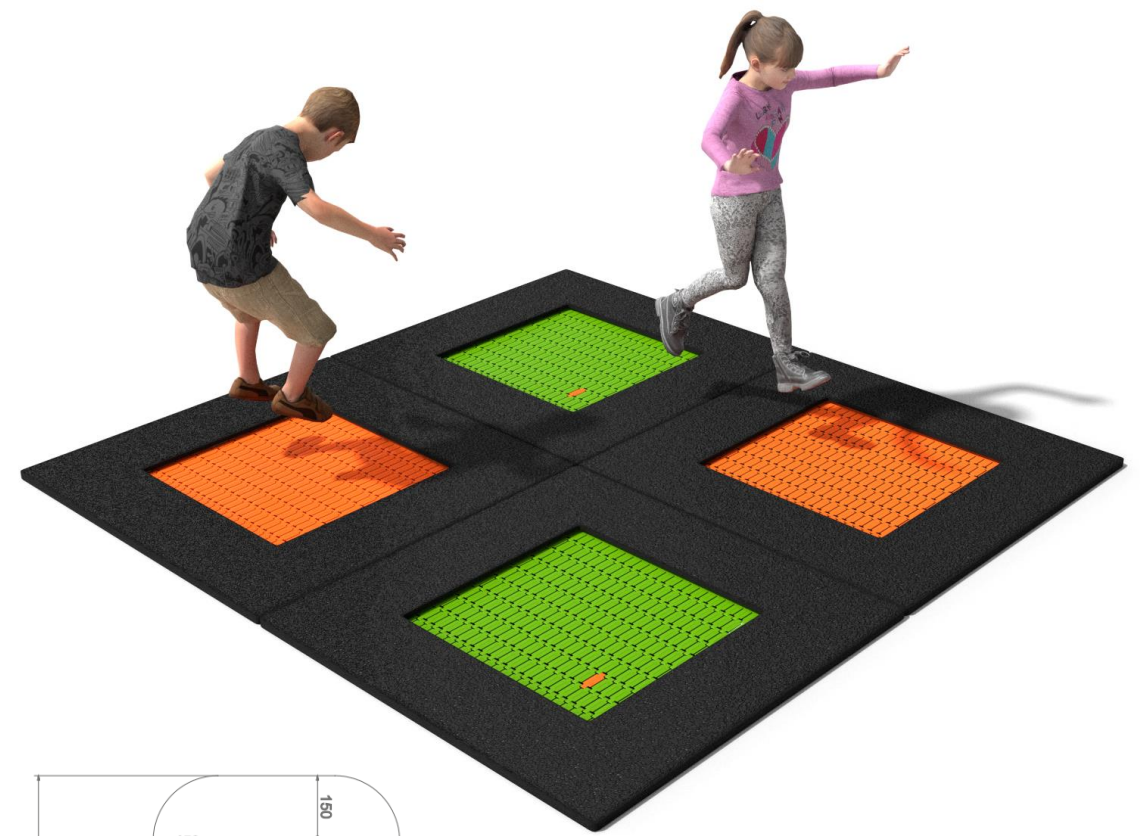

# Trampolines 2.0

Get a new experience of jumping on the new generation of trampolines. Jumping mat with minimum gaps and anti slip structure make it even more fun to use.

## MATERIALS:

- 1 Hot dip galvanised construction
  - 2 Jumping mat
  - 3 Rubber sides
- Black    Green    Red    Yellow    Blue

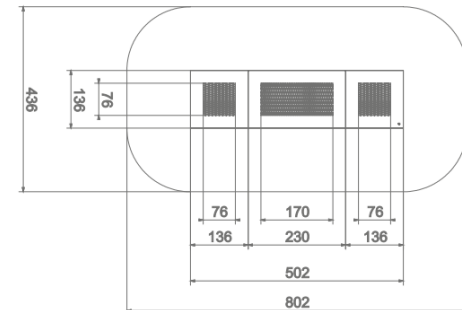



# Trampolines 2.0

Get a new experience of jumping on the new generation of trampolines. Jumping mat with minimum gaps and anti slip structure make it even more fun to use.

## MATERIALS:

1 Hot dip galvanised construction

2 Jumping mat 

3 Rubber sides 

Black    Green    Red    Yellow    Blue

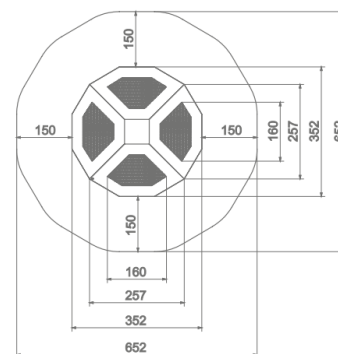
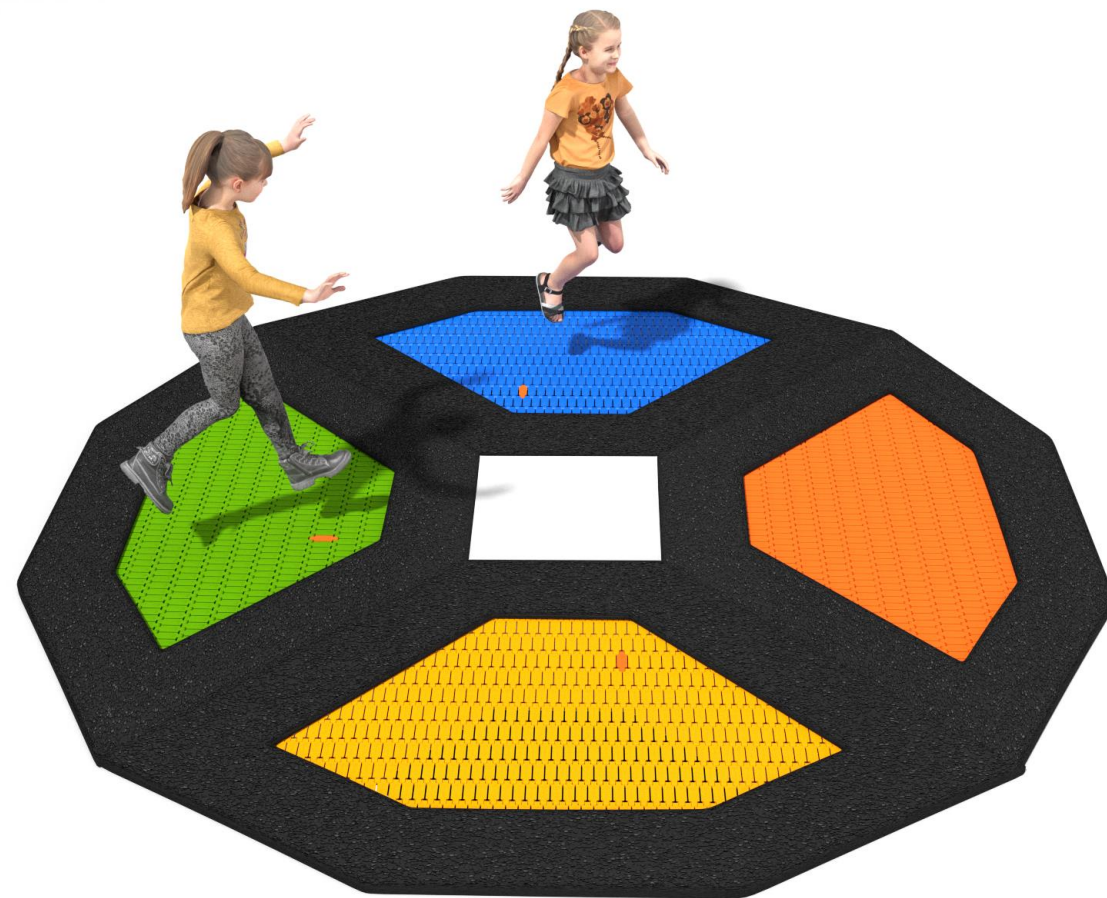

# Trampolines 2.0

Get a new experience of jumping on the new generation of trampolines. Jumping mat with minimum gaps and anti slip structure make it even more fun to use.

## MATERIALS:

1 Hot dip galvanised construction

2 Jumping mat



3 Rubber sides



Black

Green

Red

Yellow

Blue

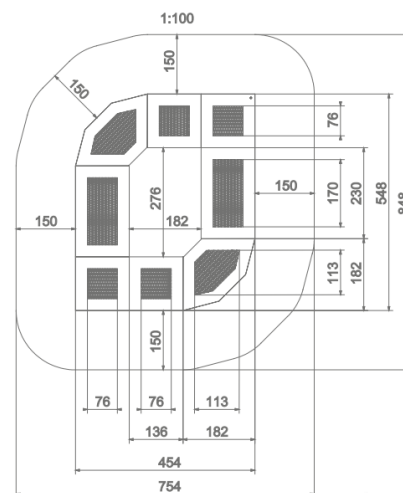
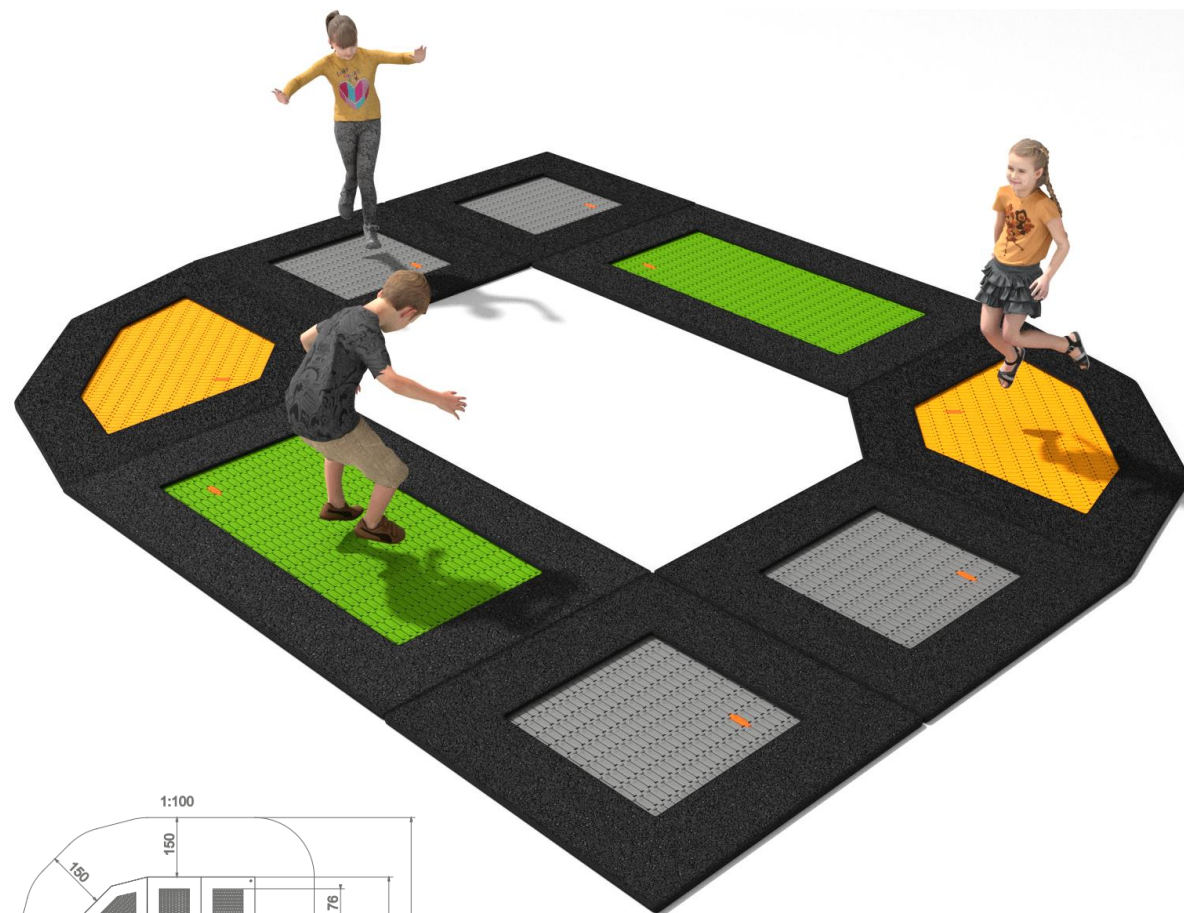

# Trampolines 2.0

Get a new experience of jumping on the new generation of trampolines. Jumping mat with minimum gaps and anti slip structure make it even more fun to use.

## MATERIALS:

1 Hot dip galvanised construction

2 Jumping mat 

3 Rubber sides   
Black Green Red Yellow Blue

## MIX & JUMP!

4201  
4207  
4208

