

KINGLO
SAND









Information about the product

Dimensions	606 x 1037 cm
Safety zone	926 x 1403 cm
Safety zone area	84,7 m ²
Overall height	604 cm
Free fall height	240 cm
Amount of users	42
Tallest element	440 cm
Heaviest element	35 kg
Product complies with EN 1176-1:2017-12	Yes
Availability of spare parts	Yes
Age range	3-12

According to EN 1176-1:2017-12 norm, the product requires applying a safety surface according to the product's free fall height.



Functions

-  Climbing
-  Balancing
-  Socializing
-  Sliding
-  Sensory Integration
-  Education panel

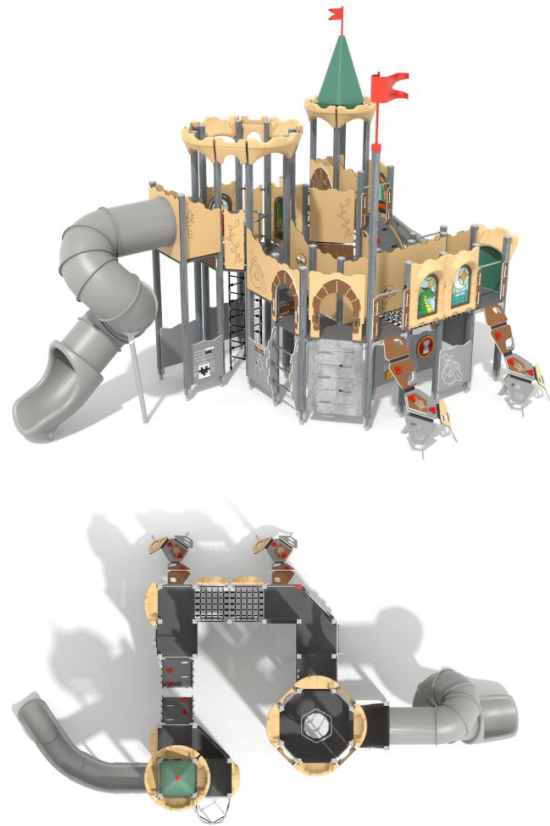
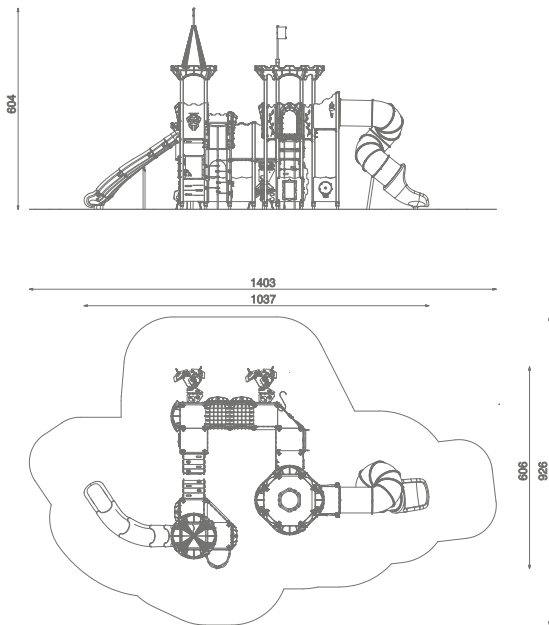

Materials



Wood from coniferous trees (Scandinavian spruce), with a cross-section of 90x90 mm, heartwood-free, layered with polyurethane adhesives completely resistant to moisture. The wood undergoes a three-stage impregnation process.

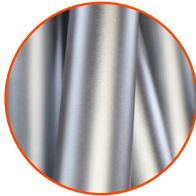

Elements made of stainless steel AISI304 totally resistant to various weather conditions.

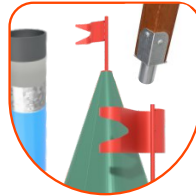

Elements made of stainless steel AISI304 totally resistant to various weather conditions.

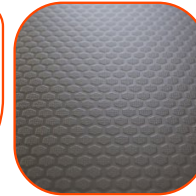

Anthracite non-slip HPL 18 mm panel with hexagonal structure characterized by maximum resistance to environmental factors and highest durability against abrasion.



Wall panels made of coloured, highest quality HPL 13 mm (black HPL 8mm), completely resistant to moisture and UV.



Wall panels made of high quality, coloured triple-layer HDPE 15 mm, resistant to moisture and UV.



16 mm diameter polypropylene ropes pp-multislip, with a steel core.



Elements made of LDPE material using rotomoulding technique.



LDPE rotomoulding window shutters with directly printed polycarbonate sheets inside.



Spring made of spring steel, with a diameter of 200 mm and a rod diameter of 20 mm. The spring set is powder galvanized and powder coated with polyester paints that are UV resistant.